

BETZ

HALI PROFİLLERİ

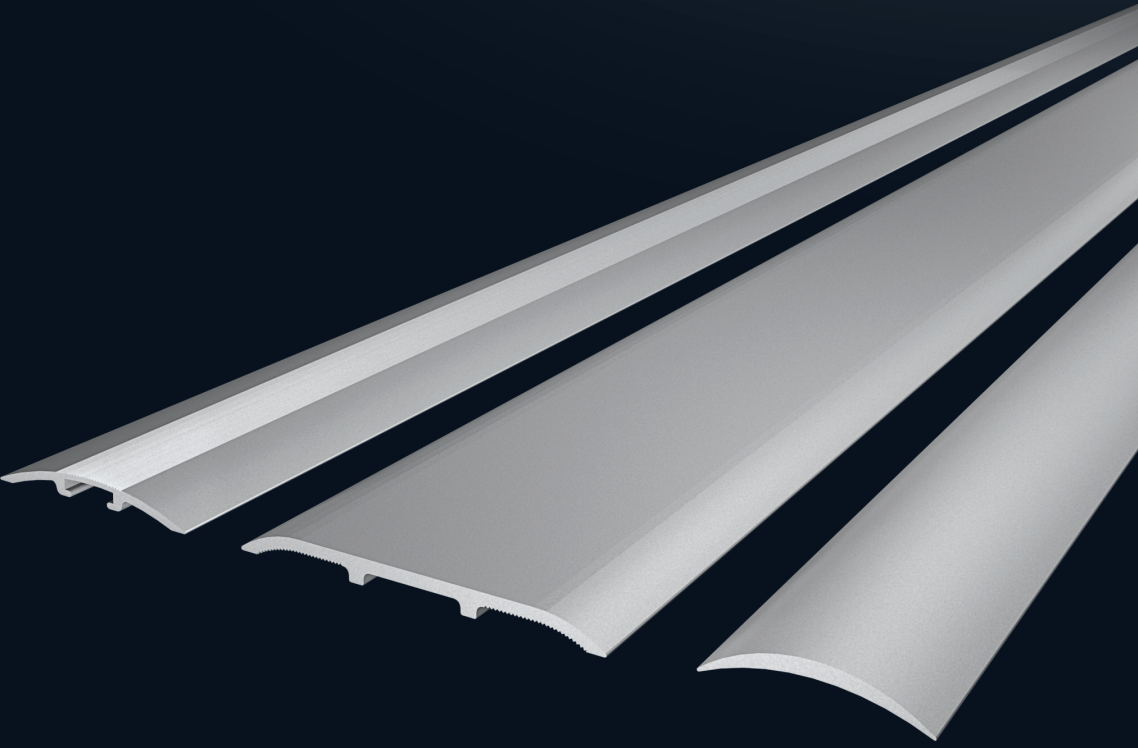

BETZ

HA 348
0.297 Kg/m



HA 349
0.131 Kg/m



HA 347
0.472 Kg/m

HA 350
0.120 Kg/m



HA 465
0.131 Kg/m



HA 3378
0.147 Kg/m

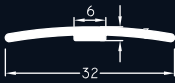

HA 3379
0.158 Kg/m

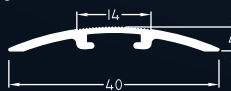

HA 3380
0.314 Kg/m



HA 206
0.426 Kg/m

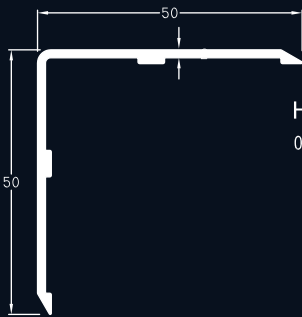

HA 521
0.576 Kg/m



HA 529
0.369 Kg/m

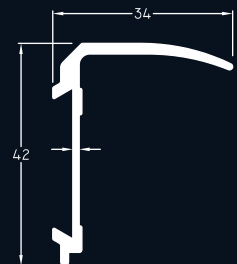

HA 343
0.122 Kg/m

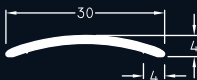

BETZ

HA 530
0.263 Kg/m



HA 531
0.358 Kg/m



HA 532
0.366 Kg/m



HA 533
0.528 Kg/m



HA 534
0.317 Kg/m

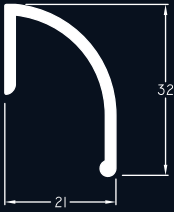

HA 1100
0.186 Kg/m



HA 1379
0.094 Kg/m



HA 1380
0.096 Kg/m



HA 1381
0.347 Kg/m



HA 1420
0.175 Kg/m



HA 1421
0.399 Kg/m

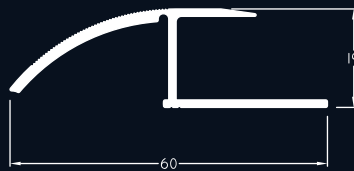

BETZ

HA 1422

0.369 Kg/m



HA 1423

0.374 Kg/m

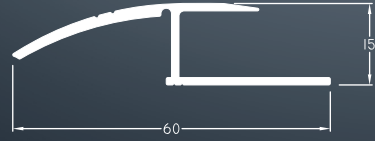

HA 1517

0.162 Kg/m



HA 1518

0.128 Kg/m



HA 1519

0.318 Kg/m

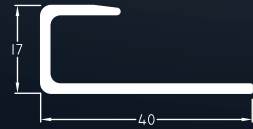

HA 1532

0.371 Kg/m

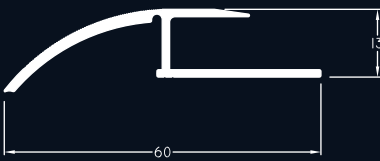

HA 1557

0.076 Kg/m



HA 1558

0.064 Kg/m



HA 1801

0.068 Kg/m



HA 1559

0.232 Kg/m

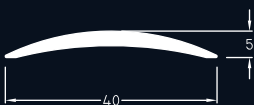

HA 1562

0.136 Kg/m



HA 1636

0.080 Kg/m



BETZ

HA 1637

0.178 Kg/m

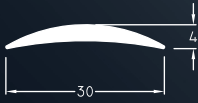

HA 1638

0.287 Kg/m



HA 1710

0.396 Kg/m

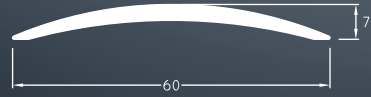

HA 1806

0.331 Kg/m

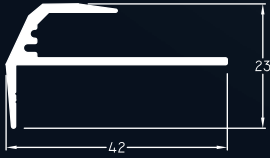

HA 1917

0.292 Kg/m

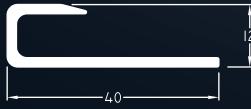

HA 1998

0.242 Kg/m



HA 2773

0.137 Kg/m



HA 2774

0.170 Kg/m

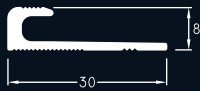

HA 2775

0.149 Kg/m

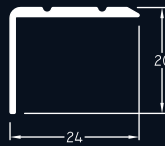

HA 2776

0.136 Kg/m



HA 2777

0.130 Kg/m



HA 2847

0.265 Kg/m

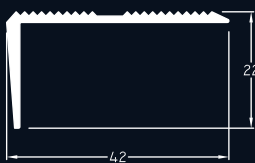

HA 2848

0.170 Kg/m



BETZ

HA 2849
0.282 Kg/m



HA 2850
0.432 Kg/m

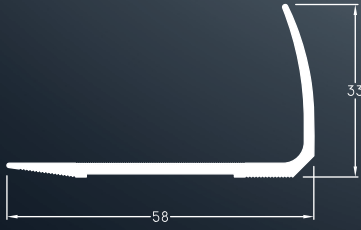

HA 2878
0.325 Kg/m

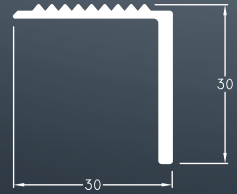

HA 2852
0.214 Kg/m



HA 2853
0.187 Kg/m

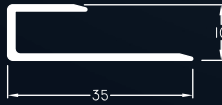

HA 2854
0.214 Kg/m



HA 2877
0.302 Kg/m



HA 2851
0.127 Kg/m

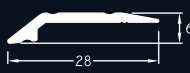

HA 2879
0.386 Kg/m



HA 2907
0.258 Kg/m

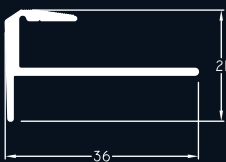

HA 2911
0.270 Kg/m



HA 2910
0.379 Kg/m



BETZ

HA 2912

0.187 Kg/m

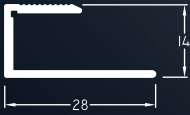

HA 2913

0.380 Kg/m



HA 3407

0.217 Kg/m

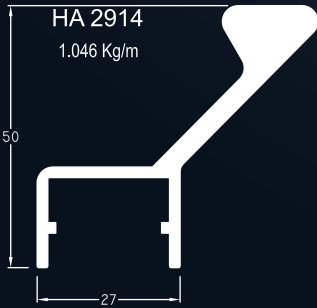

HA 2914

1.046 Kg/m

HA 2915

0.263 Kg/m



HA 3146

0.356 Kg/m

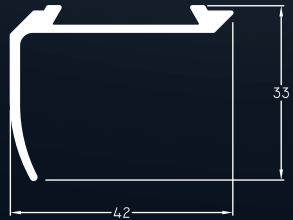

HA 2945

0.180 Kg/m

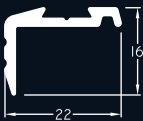

HA 2954

0.246 Kg/m

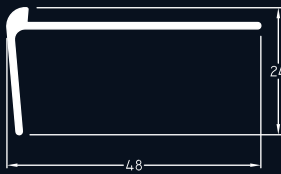

HA 2955

0.212 Kg/m



HA 2956

0.205 Kg/m



HA 2957

0.235 Kg/m



BETZ

HA 3051

0.126 Kg/m

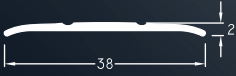

HA 3055

0.321 Kg/m

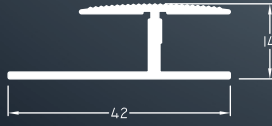

HA 3060

0.138 Kg/m

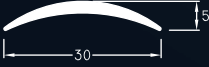

HA 3061

0.165 Kg/m

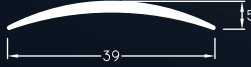

HA 3062

0.201 Kg/m

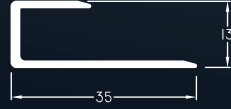

HA 3405

0.199 Kg/m

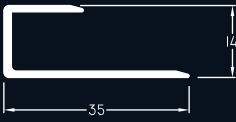

HA 3406

0.170 Kg/m



FAYANS PROFİLİ

0,138 Kg/m

