

BETZ

MOBİLYA PROFİLLERİ

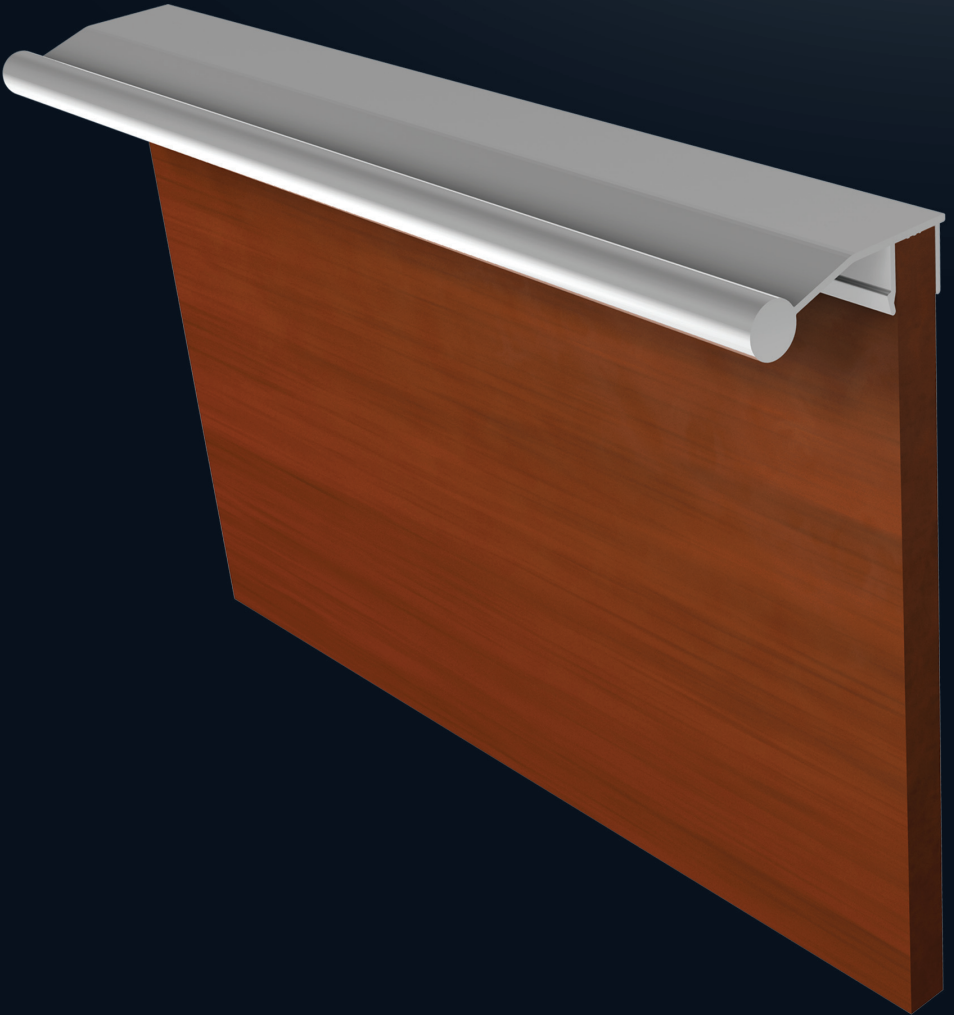

BETZ

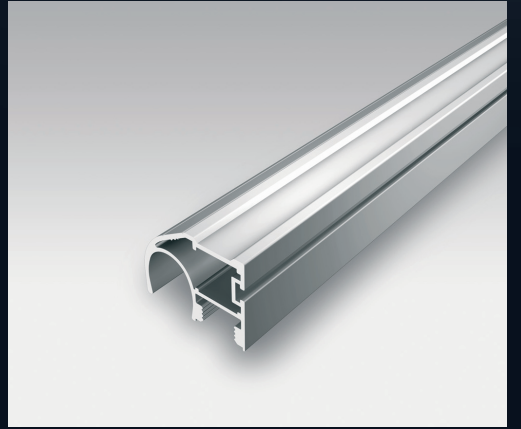

BETZ

MB 3849

0,835 Kg/m
Üst Ray Profili

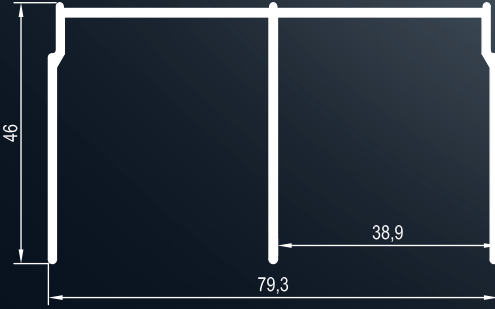

MB 3851

0,323 Kg/m
Alt Ray Profili



MB 3850

0,581 Kg/m
Alt Bağlayıcı Profil

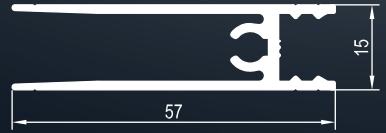

MB 3773

0,494 Kg/m
Yan Kulp Profili

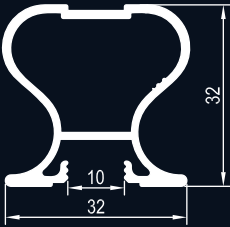

MB 4434

0,377 Kg/m
Yan Kulp Profili

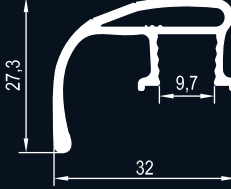

MB 3774

0,507 Kg/m
Yan Kulp Profili

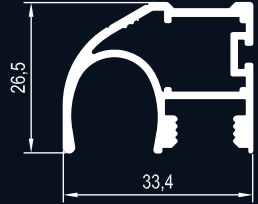

MB 4432

0,356 Kg/m
Yan Kulp Profili

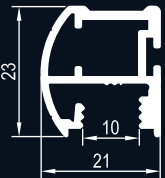

MB 3852

0,318 Kg/m
Üst Bağlayıcı Profili

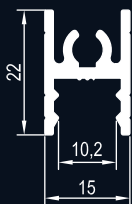

MB 4433

0,272 Kg/m
Ara Kayıt Profili

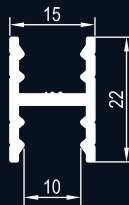

MB 4054

0,110 Kg/m
Kulp Profili



BETZ

MB 7029

0,287 Kg/m
Kapak Çerçeve Profili

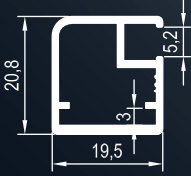

MB 7215

0,282 Kg/m
Kapak Çerçeve Profili

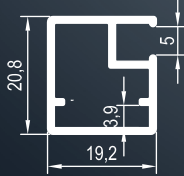

MB 7267

0,276 Kg/m
Kapak Çerçeve Profili

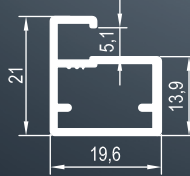

MB 7268

0,366 Kg/m
Kapak Çerçeve Profili

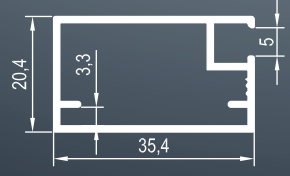

MB 7030

0,391 Kg/m
Kapak Çerçeve Profili



MB 7269

0,374 Kg/m
Kapak Çerçeve Profili

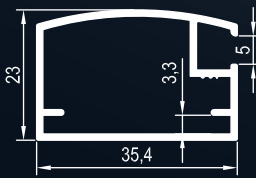

MB 7264

0,468 Kg/m
Kapak Çerçeve Profili



MB 7031

0,418 Kg/m
Kapak Çerçeve Profili

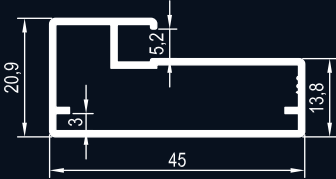

MB 7216

0,453 Kg/m
Kapak Çerçeve Profili

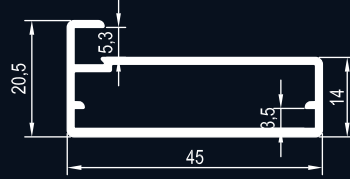

MB 7263

0,580 Kg/m
Kapak Çerçeve Profili

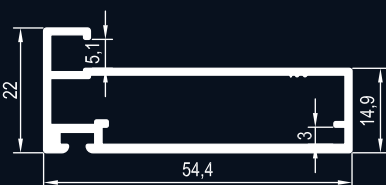

MB 7265

0,452 Kg/m
Kapak Çerçeve Profili

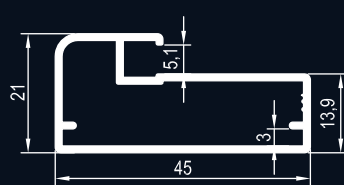

BETZ

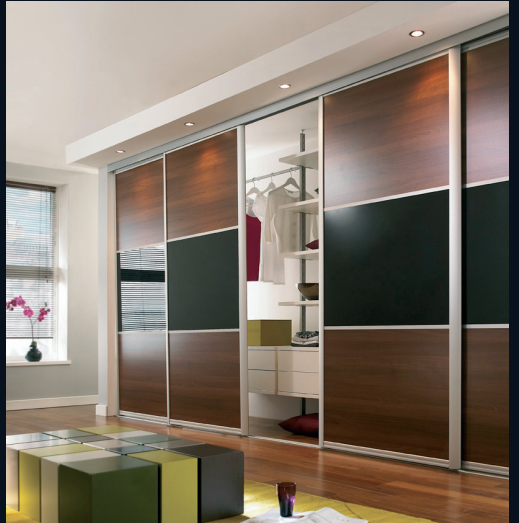
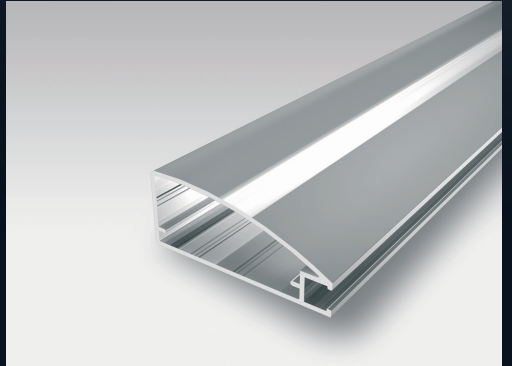
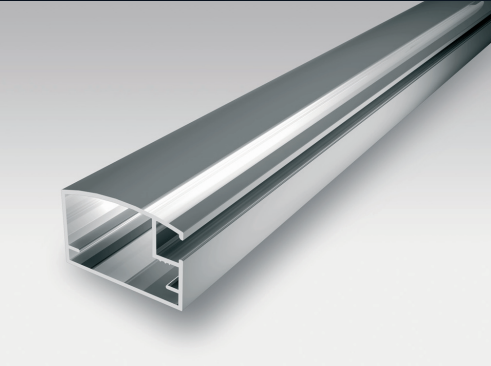
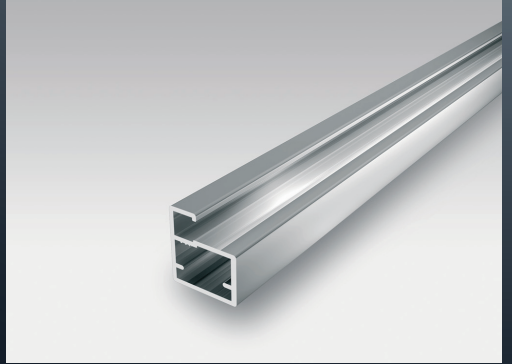

BETZ

MB 7196

0,513 Kg/m
Kapak Çerçeve Profili

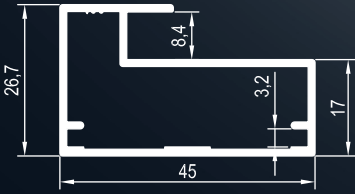

MB 7266

0,415 Kg/m
Kapak Çerçeve Profili

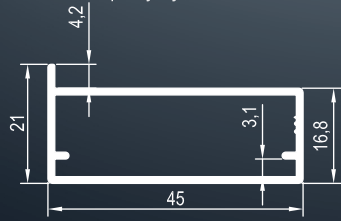

MB 7217

0,514 Kg/m
Kapak Çerçeve Profili

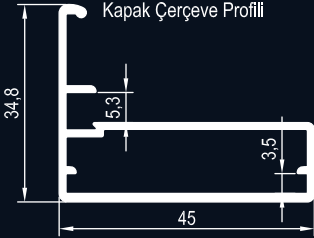

MB 7197

0,477 Kg/m
Ara Kayıt

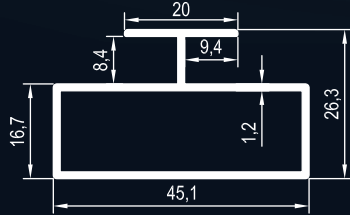

MB 7262

0,414 Kg/m
Ara Kayıt

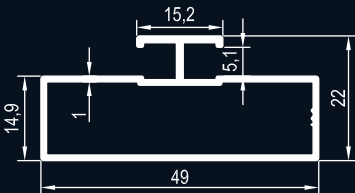

MB 7288

0,337 Kg/m
Kulp Profili

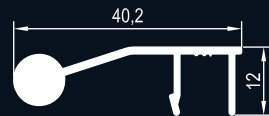

BETZ

MB 7289

0,457 Kg/m
Üst Ray Profili



MB 7038

0,527 Kg/m
Lüks Yan Kulp Profili

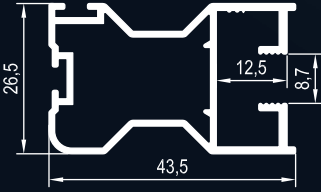

MB 7039

0,372 Kg/m
Yan Kulp Profili



MB 7037

0,302 Kg/m
Ara Kayıt Profili

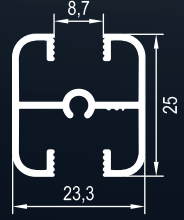

MB 7036

0,247 Kg/m
Üst Bağlayıcı Profili

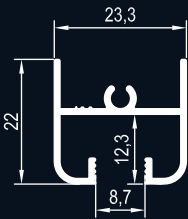

MB 7028

0,469 Kg/m
Üst Bağlayıcı Profili

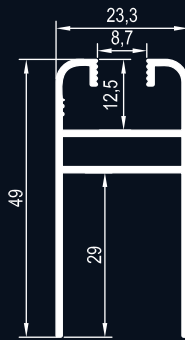

MB 7033

0,210 Kg/m
Alt Ray Profili



MB 7034

0,239 Kg/m
Alt Ray Profili



BETZ

MB 7027

0,473 Kg/m
Üst Ray Profili



MB 7024

0,452 Kg/m
Üst Ray Profili



MB 7043

0,519 Kg/m
Yan Kulp Profili

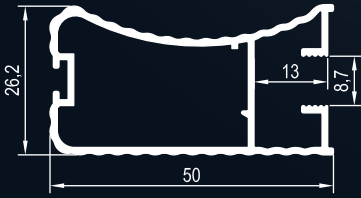

MB 7041

0,349 Kg/m
Ara Kayıt Profili

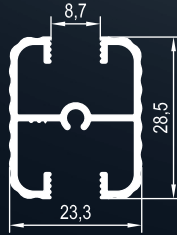

MB 7040

0,257 Kg/m
Üst Bağlayıcı Profil

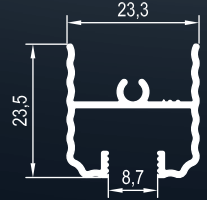

MB 7042

0,448 Kg/m
Alt Bağlayıcı Profil

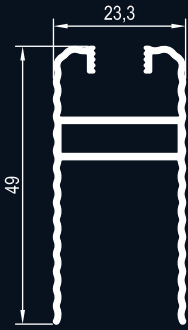

MB 7293

0,472 Kg/m
Alt Bağlayıcı Profil

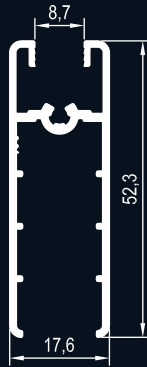

MB 7294

0,272 Kg/m
Ara Kayıt Profili



MB 7106

0,245 Kg/m
Ara Kayıt Profili

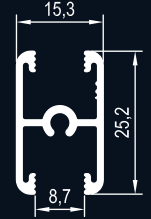

MB 7292

0,481 Kg/m
Yan Kulp Profili

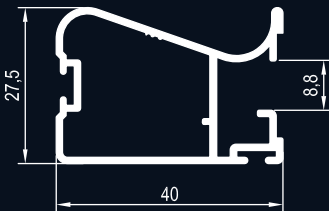

MB 7290

0,414 Kg/m
Yan Kulp Profili

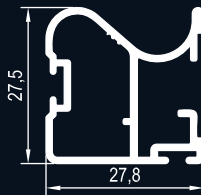

MB 7291

0,204 Kg/m
Üst Bağlayıcı Profil

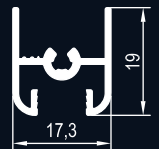

BETZ

MB 7201

0,364 Kg/m
Kulp Profili



MB 7277

0,386 Kg/m
Kulp Profili

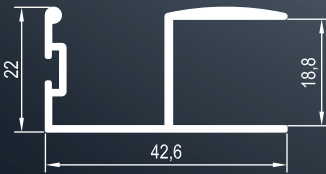

MB 7278

0,342 Kg/m
Kulp Profili



MB 7206

0,205 Kg/m
Kulp Profili

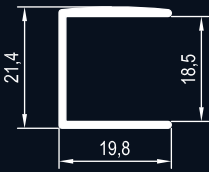

MB 7193

0,190 Kg/m
Kulp Profili

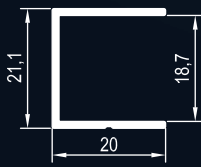

MB 7276

0,192 Kg/m
Kulp Profili

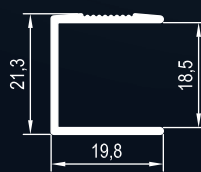

MB 7275

0,264 Kg/m
Kulp Profili

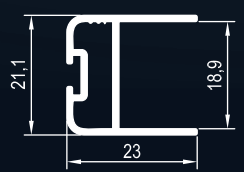

MB 7194

0,427 Kg/m
Kulp Profili

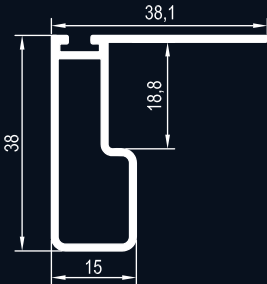

MB 7279

0,476 Kg/m
Kulp Profili

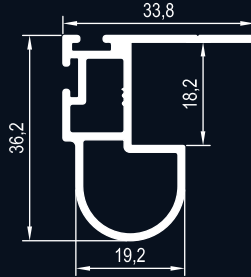

MB 7281

0,262 Kg/m
Kulp Profili

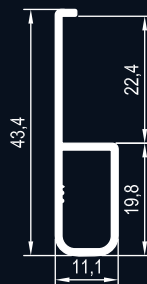

MB 7273

0,234 Kg/m
Kulp Profili

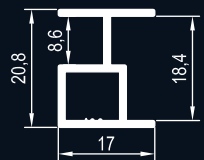

BETZ

MB 7274

0,281 Kg/m
Kulp Profili

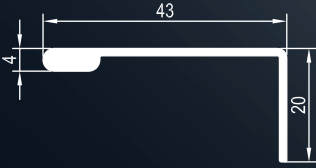

MB 7284

0,383 Kg/m
Kulp Profili



MB 7287

0,206 Kg/m
Kulp Profili

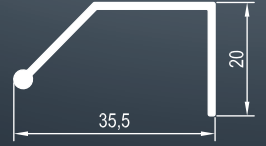

MB 7280

0,405 Kg/m
Kulp Profili

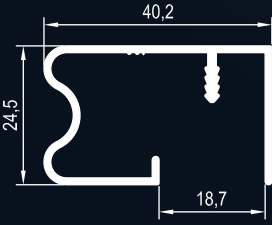

MB 7202

0,577 Kg/m
Kulp Profili



MB 7285

0,562 Kg/m
Kulp Profili

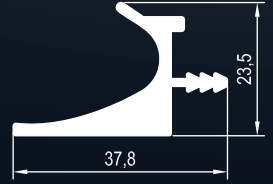

BETZ

MB 7026

0,117 Kg/m
F Çıta Profili

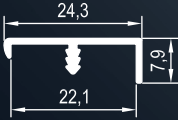

MB 7025

0,105 Kg/m
F Çıta Profili

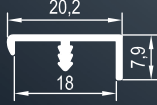

MB 7327

0,091 Kg/m
F Çıta Profili

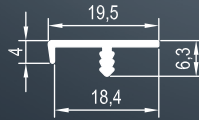

MB 7330

0,055 Kg/m
T Çıta Profili

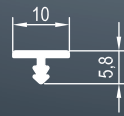

MB 7333

0,087 Kg/m
T Çıta Profili

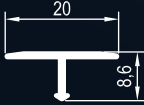

MB 7335

0,102 Kg/m
T Çıta Profili



MB 7199

0,064 Kg/m
Lama Profili



MB 7035

0,115 Kg/m
Bombe Çıta Profili



MB 7272

0,108 Kg/m
Bombe Çıta Profili



MB 7334

0,117 Kg/m
U Çıta Profili

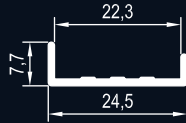

MB 7023

0,098 Kg/m
U Çıta Profili

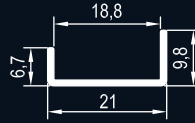

MB 7032

0,091 Kg/m
U Çıta Profili



MB 7286

0,618 Kg/m
Kulp Profili

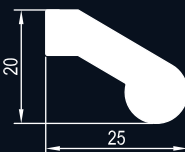

MB 7331

0,153 Kg/m
Sunta Profili

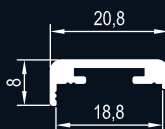

MB 7332

0,146 Kg/m
Sunta Profili

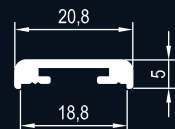

BETZ

MB 7310

0,389 Kg/m
Sunta Profili

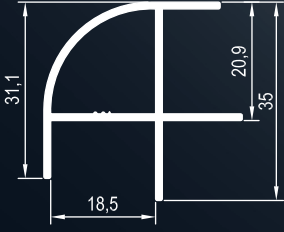

MB 7309

0,298 Kg/m
Sunta Profili

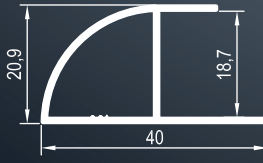

MB 7307

0,213 Kg/m
Sunta Profili

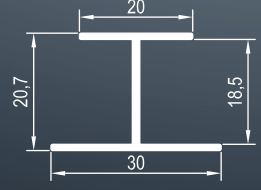

MB 7308

0,178 Kg/m
Sunta Profili

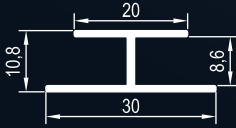

MB 7306

0,228 Kg/m
Sunta Profili

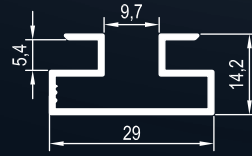

MB 7044

0,204 Kg/m
Askı Boru Profili



MB 7045

0,179 Kg/m
Askı Boru Profili

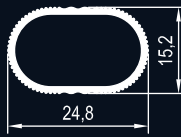

MB 7295

0,198 Kg/m
Askı Boru Profili

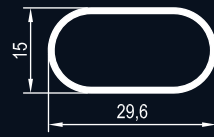

MB 7296

0,144 Kg/m
Askı Boru Profili

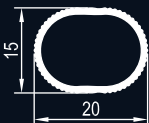

MB 7046

0,073 Kg/m
Askı Boru Profili



MB 7303

0,110 Kg/m
Ranza Profili



BETZ

MB 7304

0,693 Kg/m
Ranza Profili

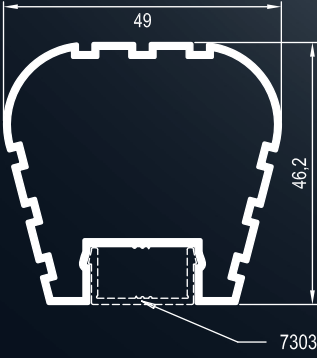

MB 7305

0,421 Kg/m
Ranza Profili

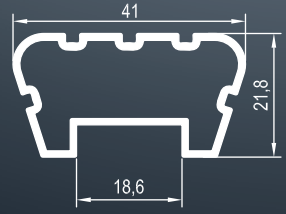

MB 7297

0,242 Kg/m
Baza Dönüş Profili

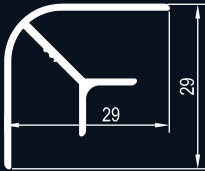

MB 7207

0,295 Kg/m
Tezgah Önü Profili

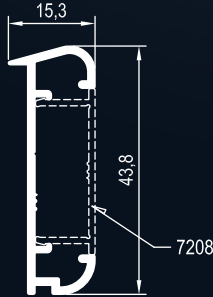

MB 7208

0,143 Kg/m
Tezgah Önü Profili

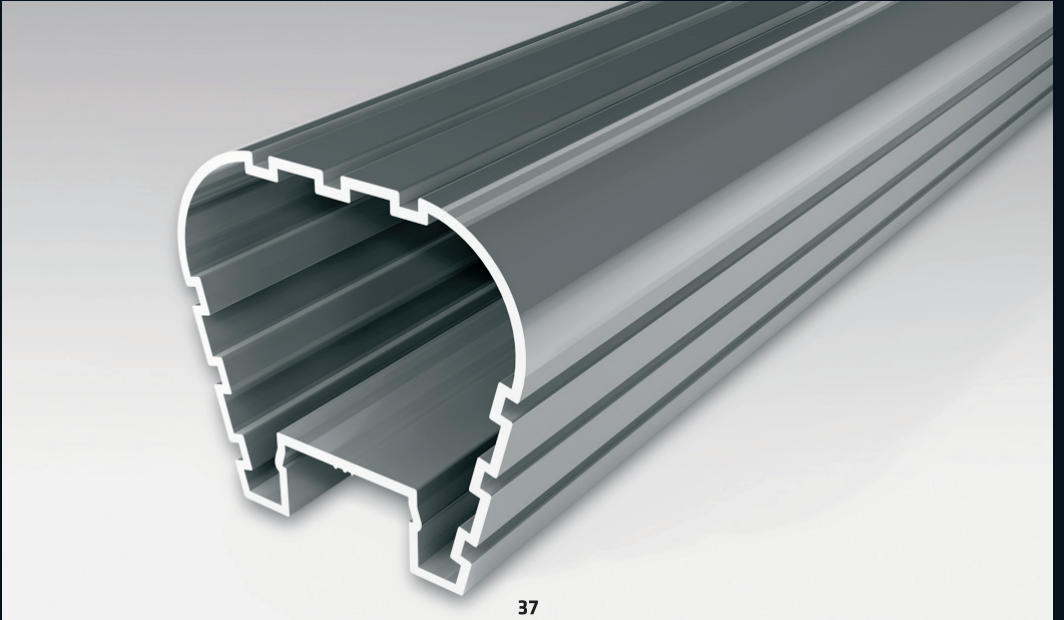

BETZ

MB 7198

0,559 Kg/m
Çizgili Baza Profili



MB 7203

0,548 Kg/m
Düz Baza Profili



MB 7204

0,603 Kg/m
Düz Baza Profili



MB 7205

0,616 Kg/m
Çizgili Baza Profili

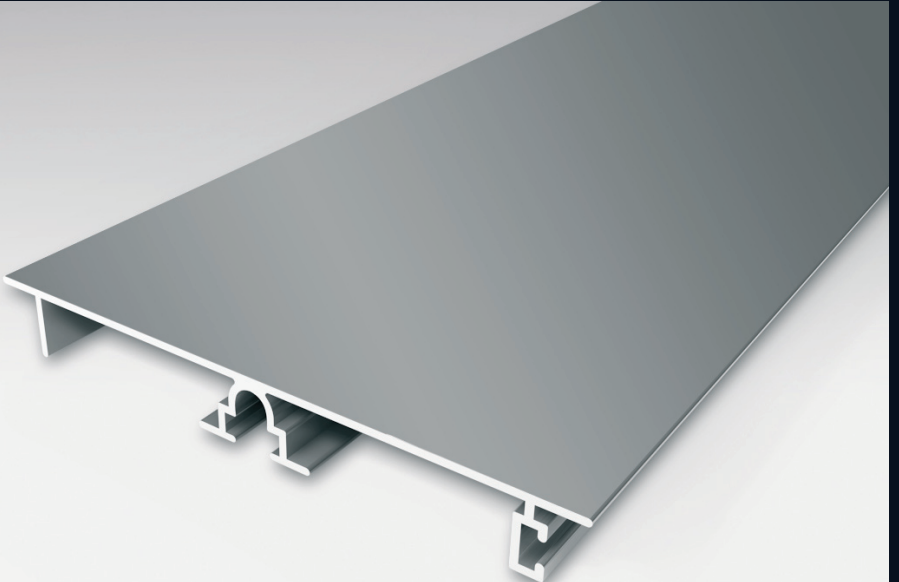

BETZ

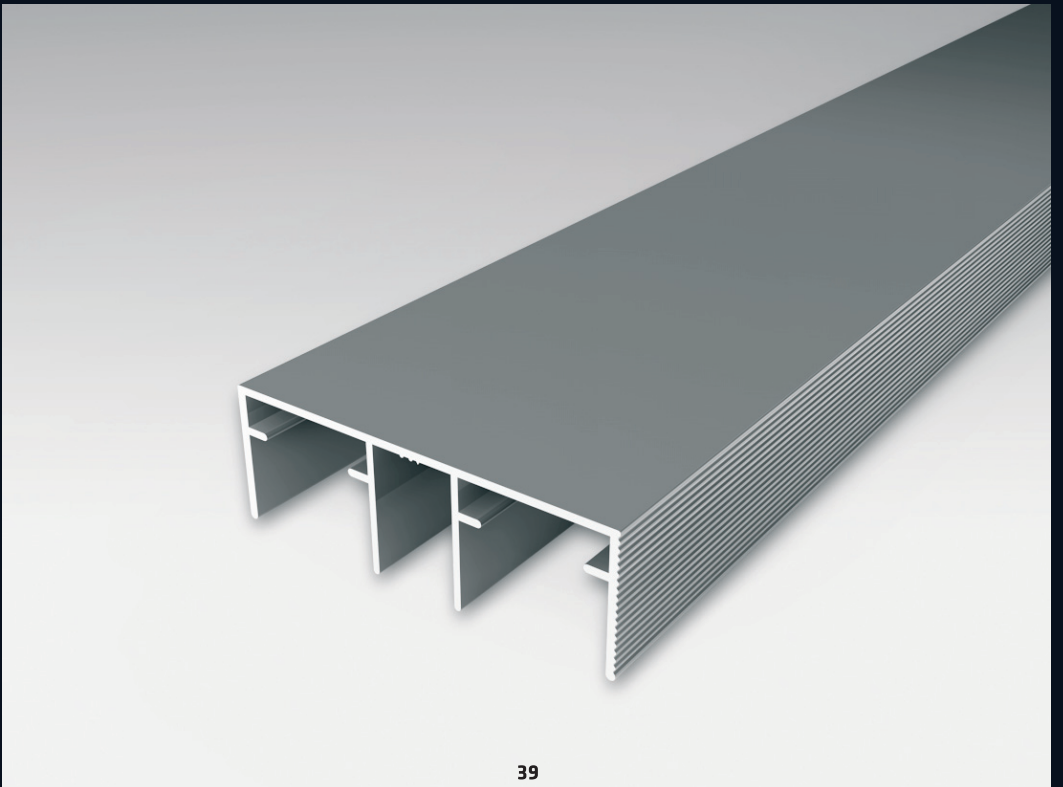

BETZ

MB 7317

0,440 Kg/m
Üst Ray Profili



MB 7323

0,396 Kg/m
Alt Ray Profili

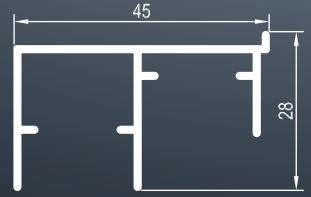

MB 7320

0,262 Kg/m
Alt Ray Profili



MB 7321

0,294 Kg/m
Alt Ray Profili



MB 7318

0,110 Kg/m
Alt Ray Profili

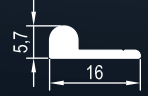

MB 7325

0,268 Kg/m
Alt Ray Profili



MB 7195

0,120 Kg/m
Alt Ray Profili

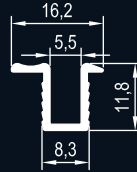

MB 7300

0,059 Kg/m
Alt Ray Profili

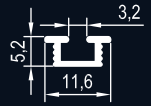

MB 7322

0,307 Kg/m
Üst Ray Profili

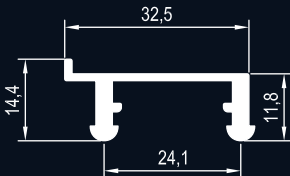

MB 7324

0,258 Kg/m
Alt Ray Profili

